

Le nombre zéro

dé

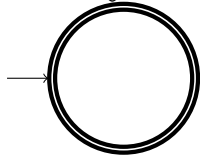

Le nombre un

dé

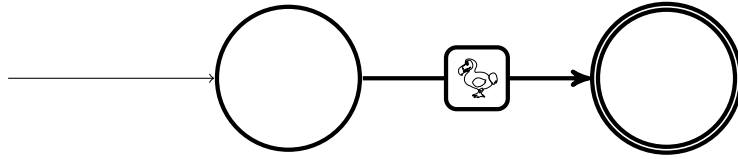

Le nombre moins un

dé

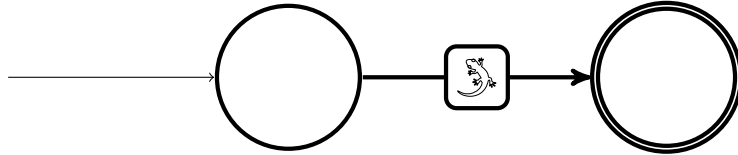

Le nombre un

dé

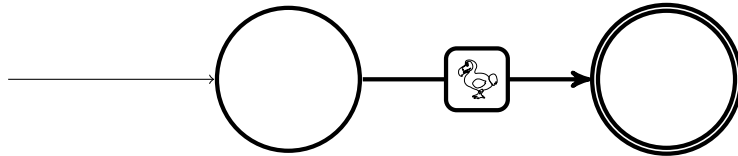

Le nombre moins un

dé

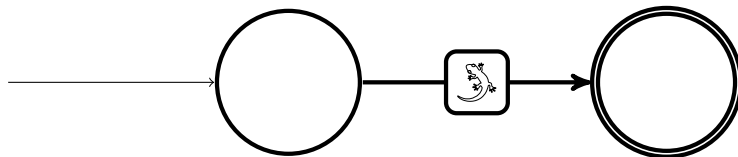

Le nombre un

dé

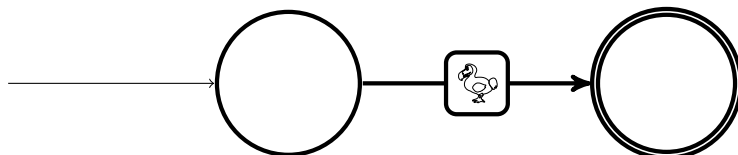

Le nombre moins un

dé

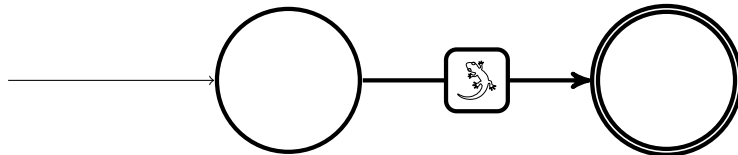

Le nombre deux

dé

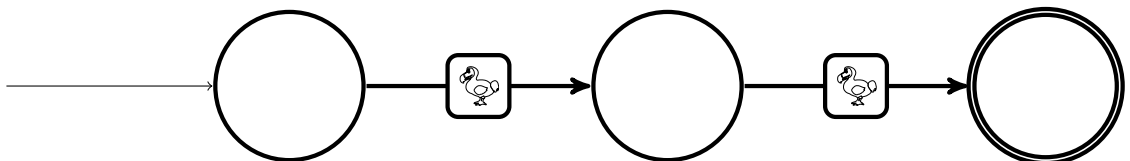

Le nombre moins deux

dé

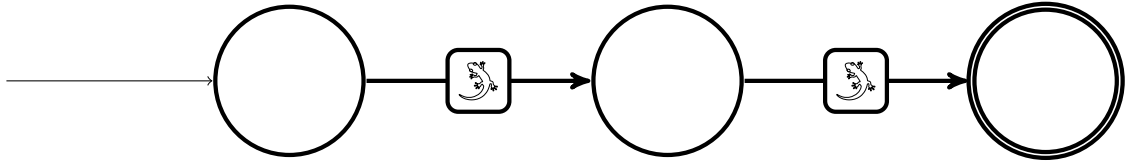

Le nombre trois

dé

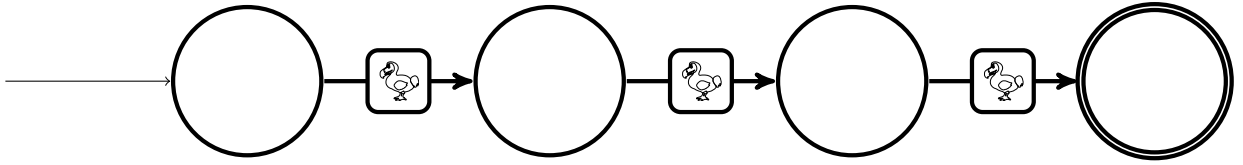

Le nombre moins trois

dé

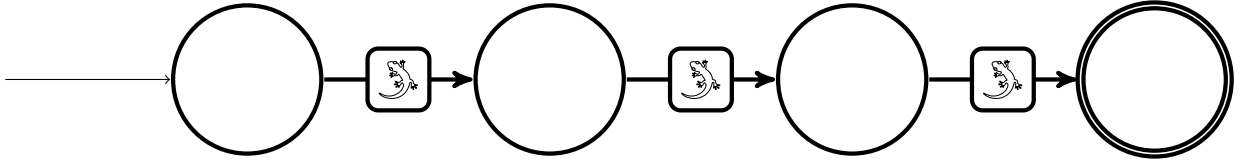

Le nombre un demi

dé

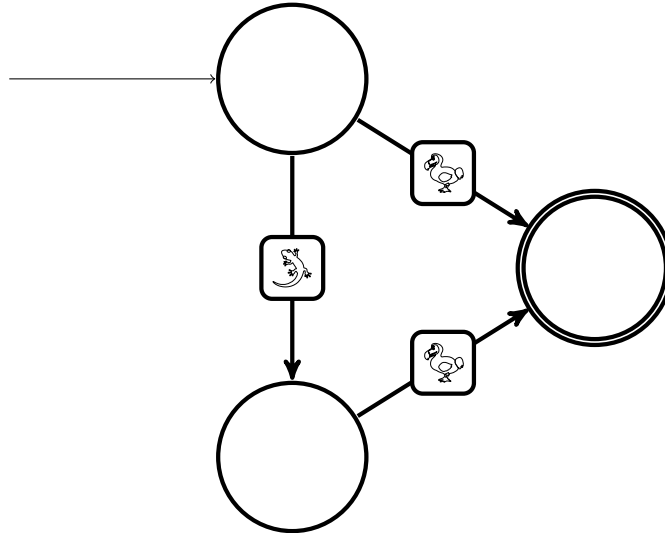

Le nombre moins un demi

dé

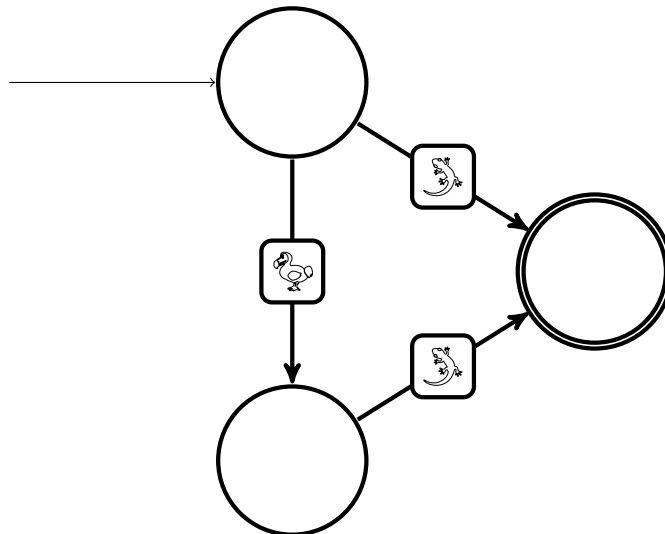

Le nombre un et demie :

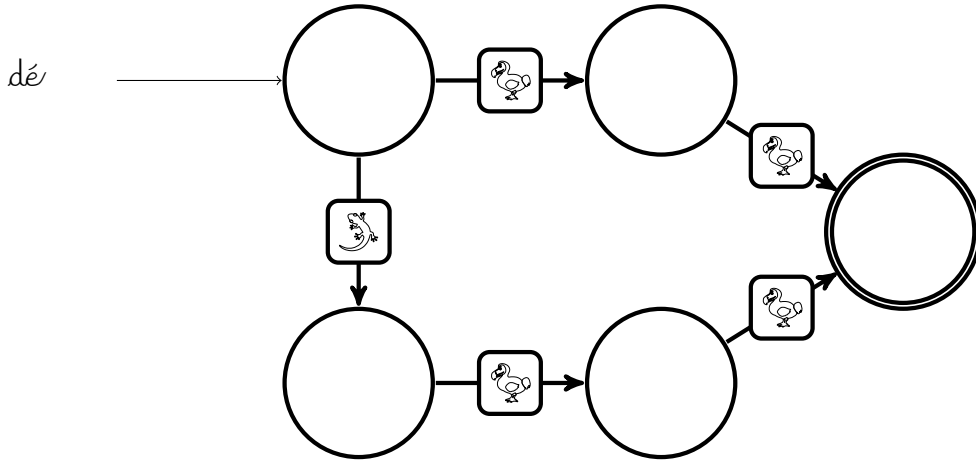

Le nombre moins un et demie :

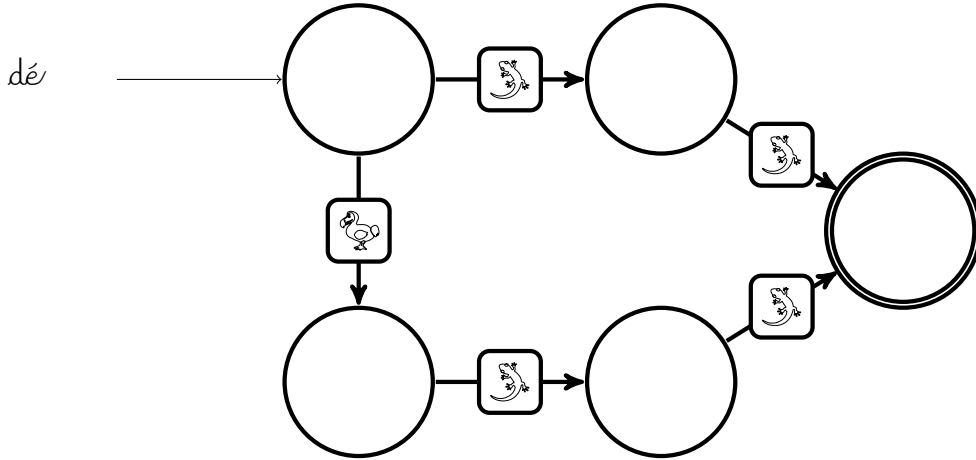

Le nombre deux et demie :

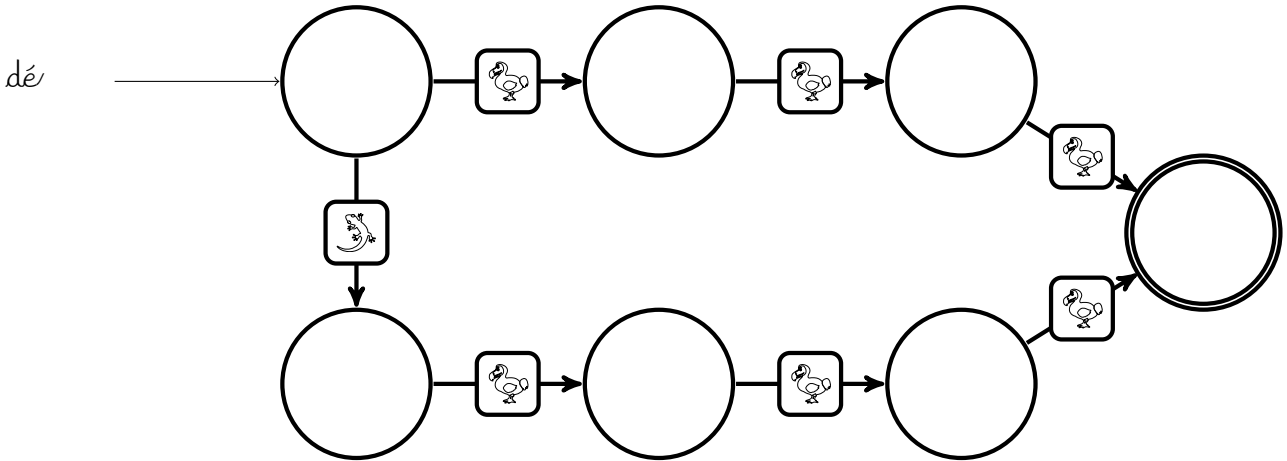

Le nombre moins deux et demie :

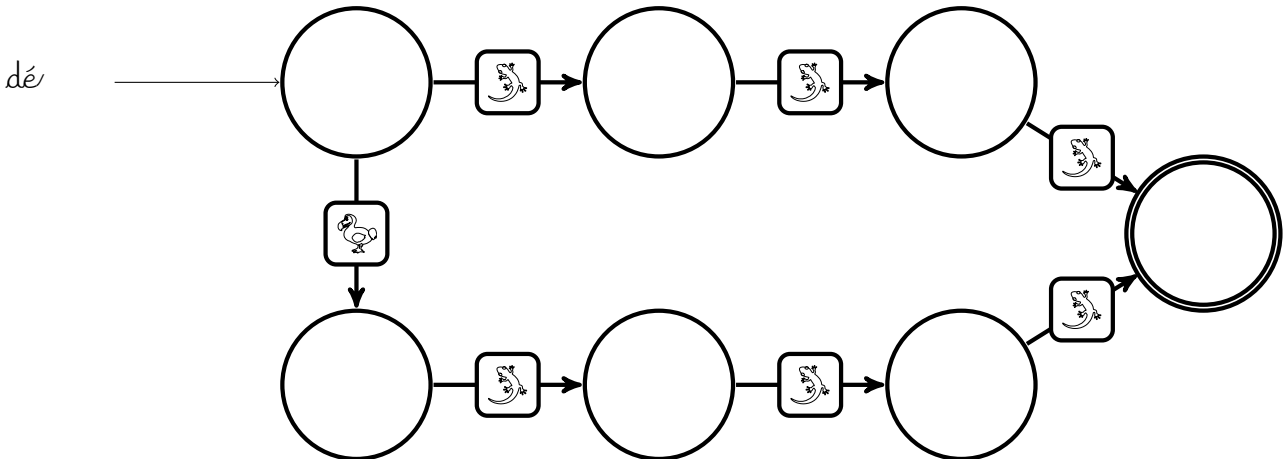

Le nombre un quart

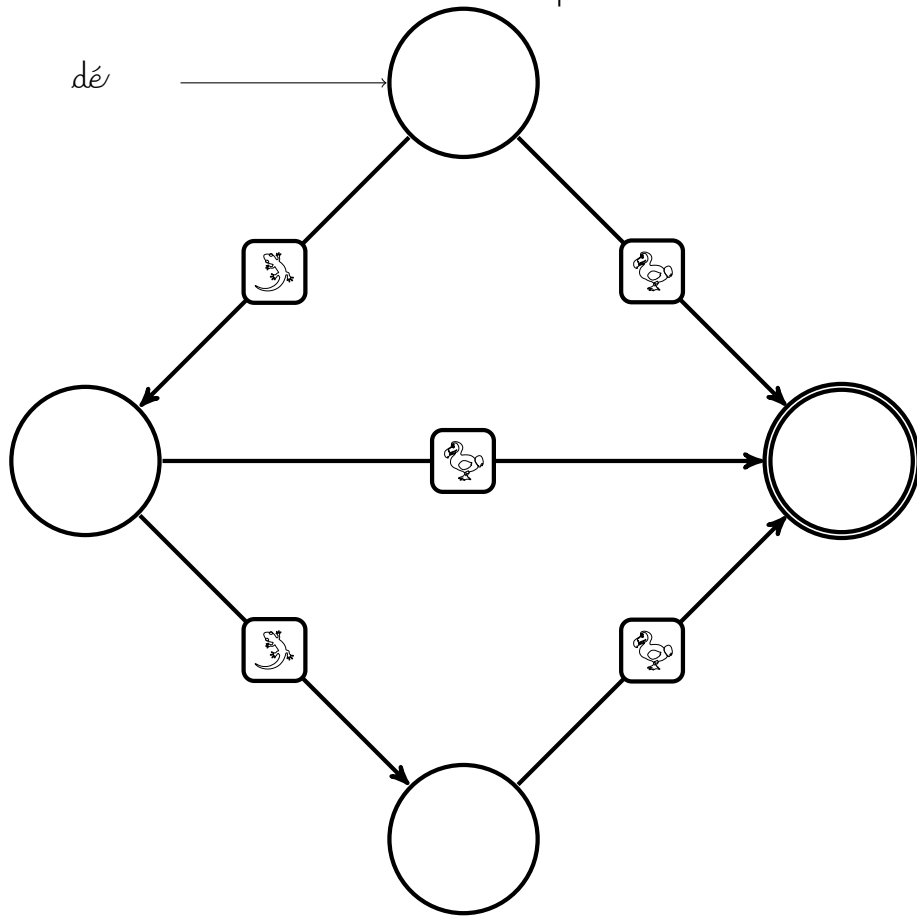

Le nombre moins un quart

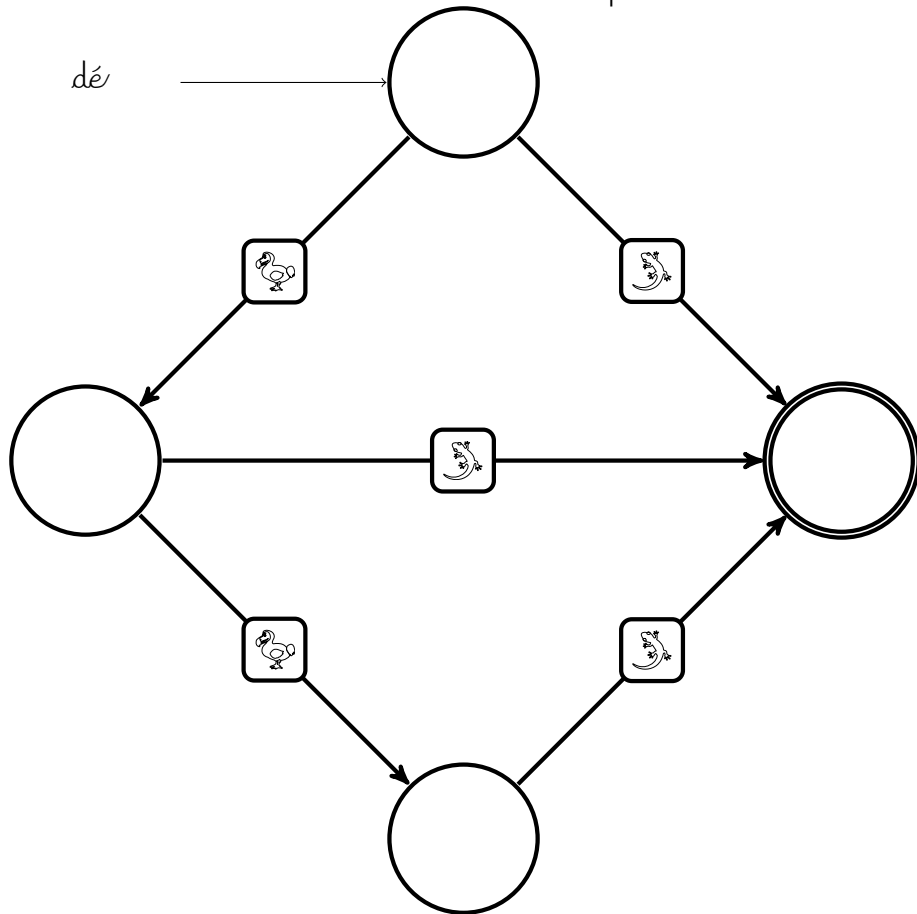

Le nombre trois quart

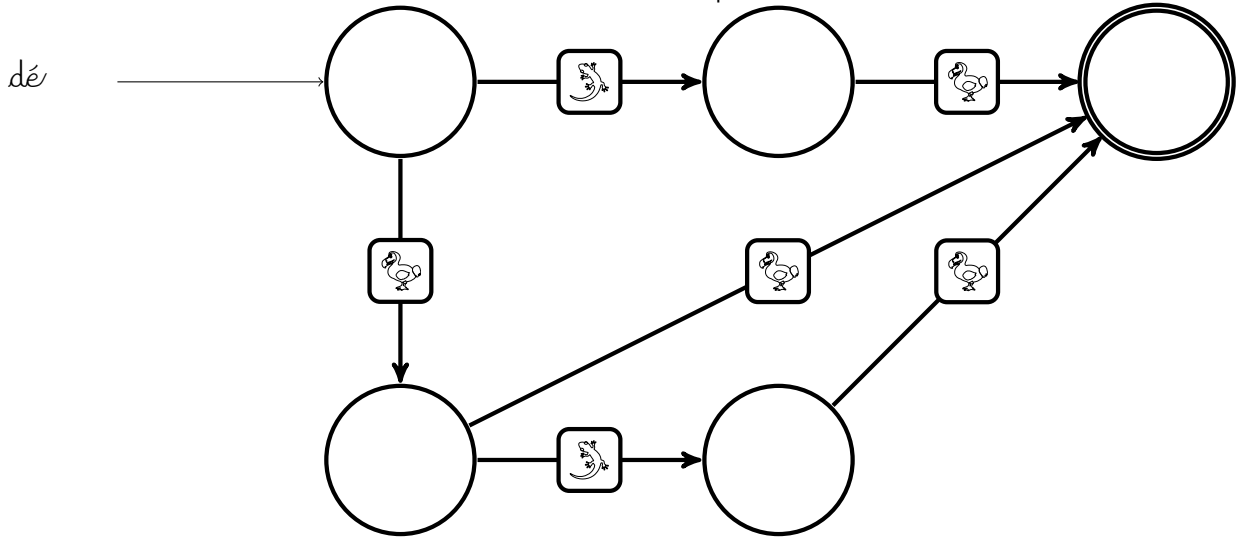

Le nombre moins trois quart

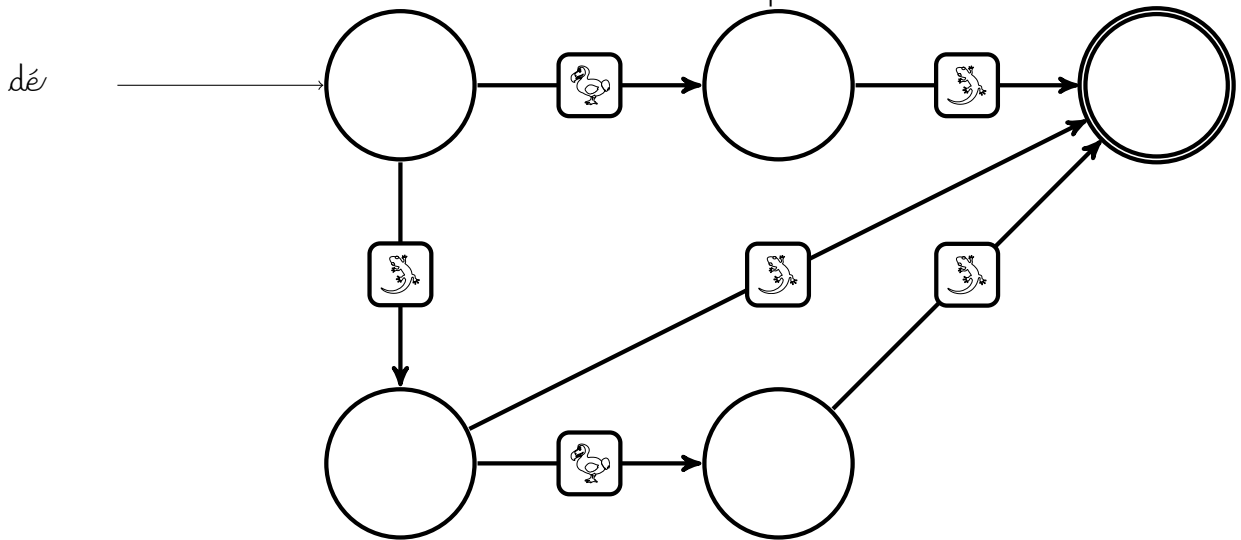

L'étoile

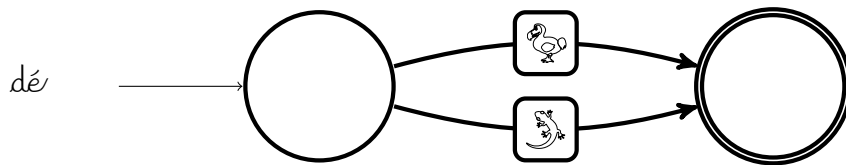

Le nombre zéro

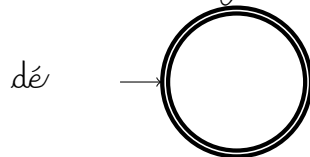

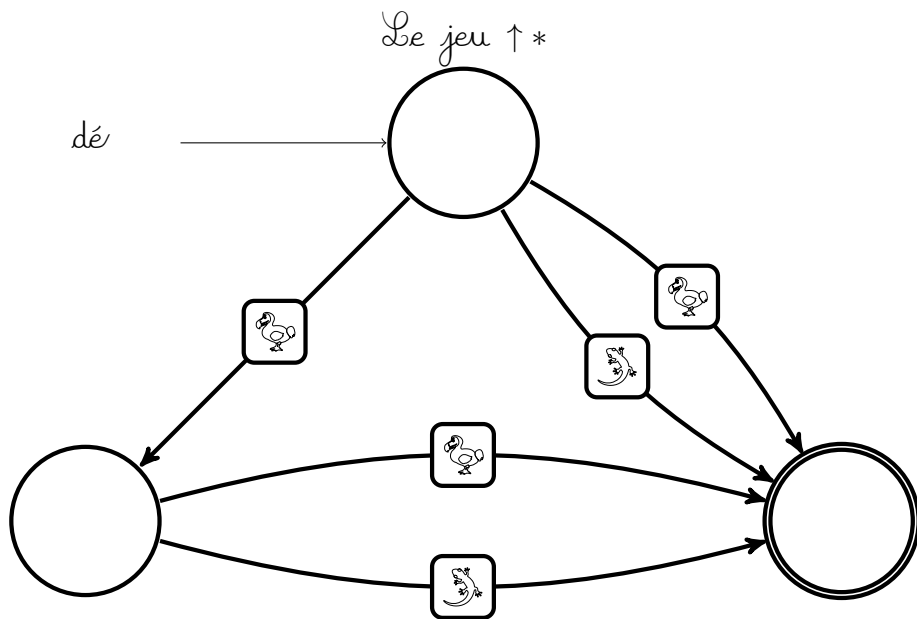
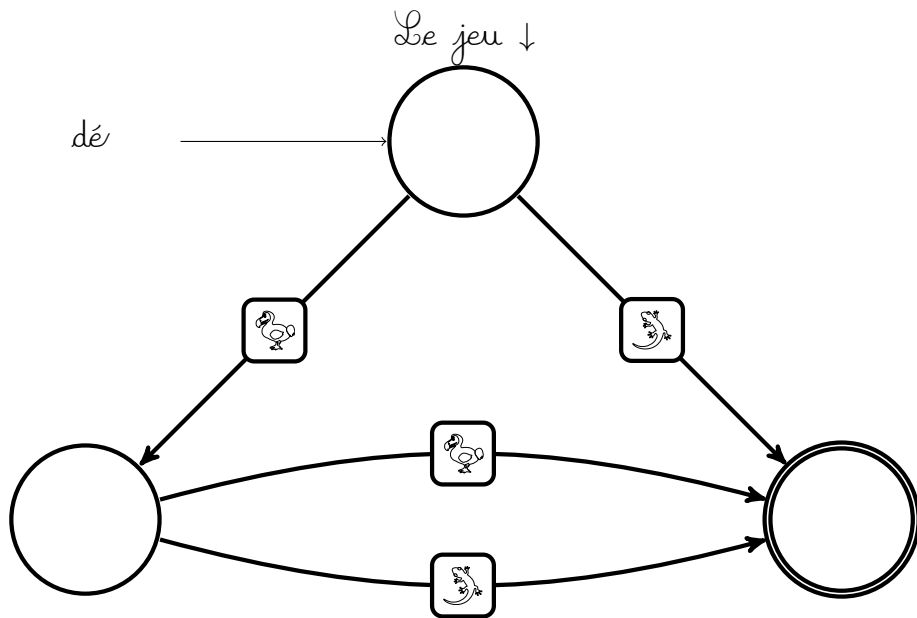
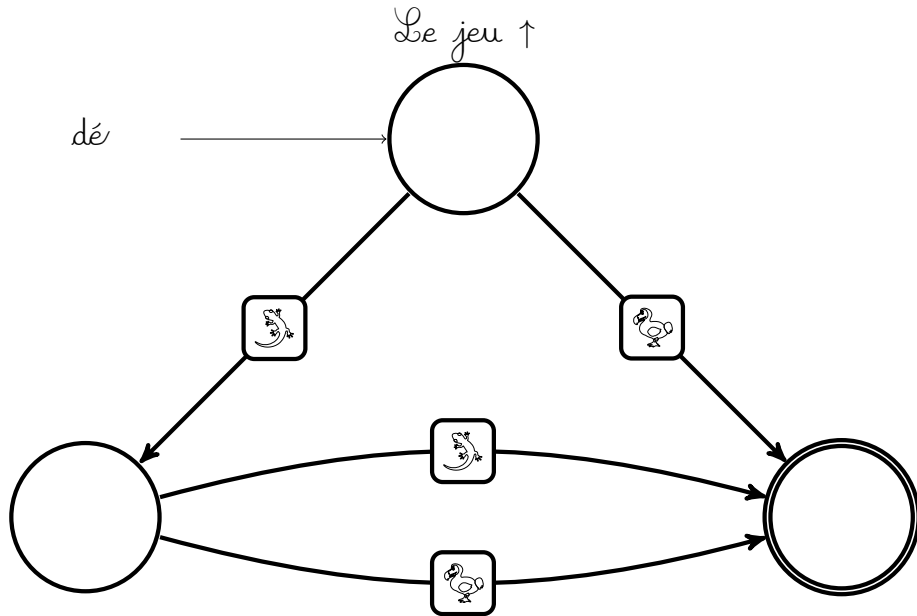

Le jeu $\uparrow\uparrow$

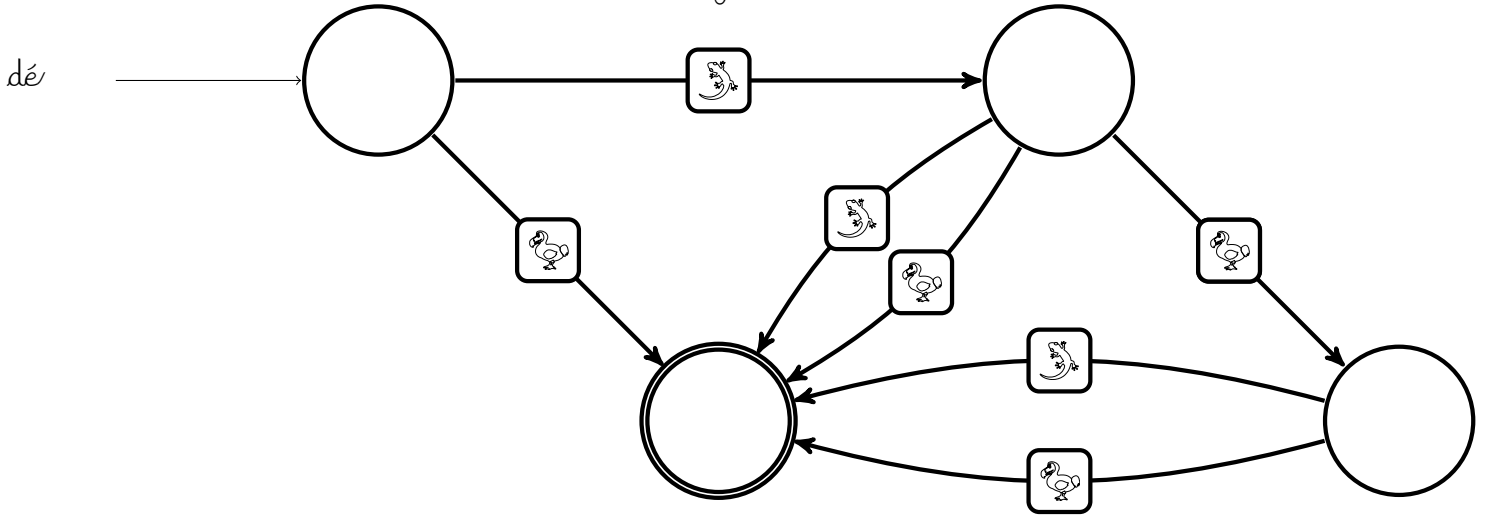

Le jeu $\downarrow\downarrow$

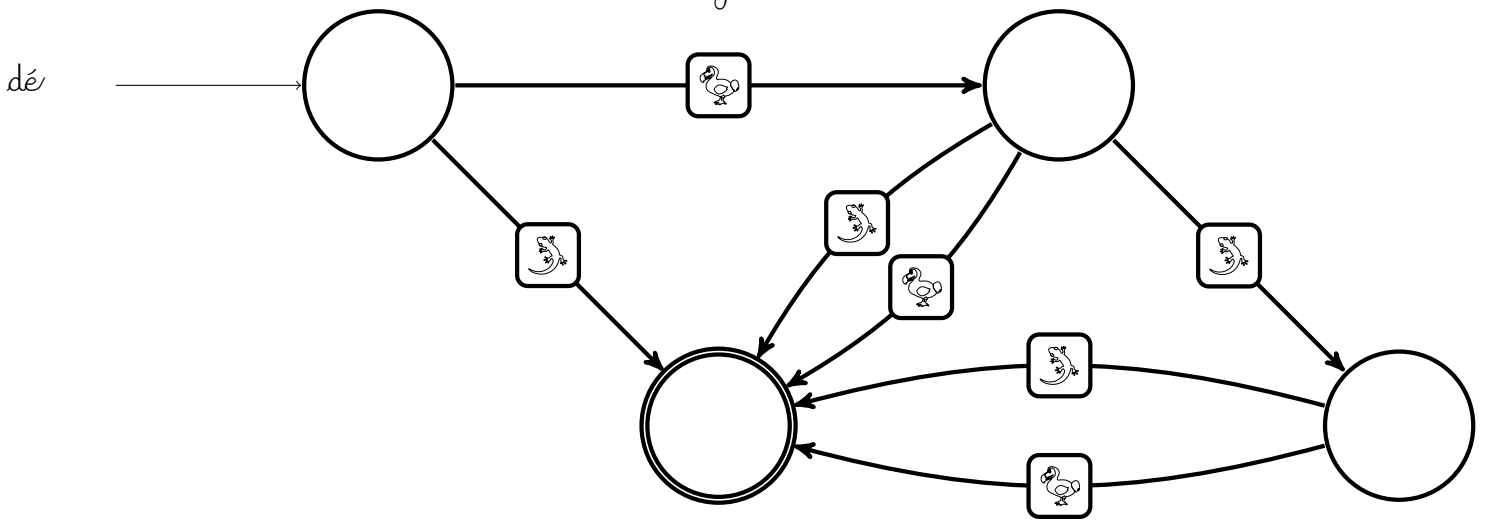

Le jeu $\uparrow\uparrow^*$

